

#### 4. Mounting positions SG

-  Vent plug
-  Drain plug

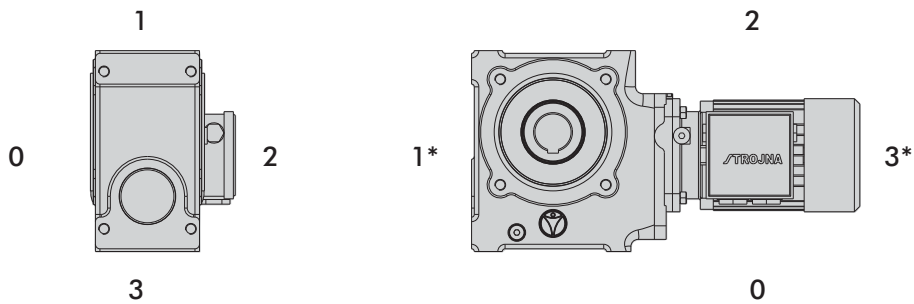
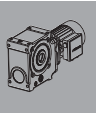
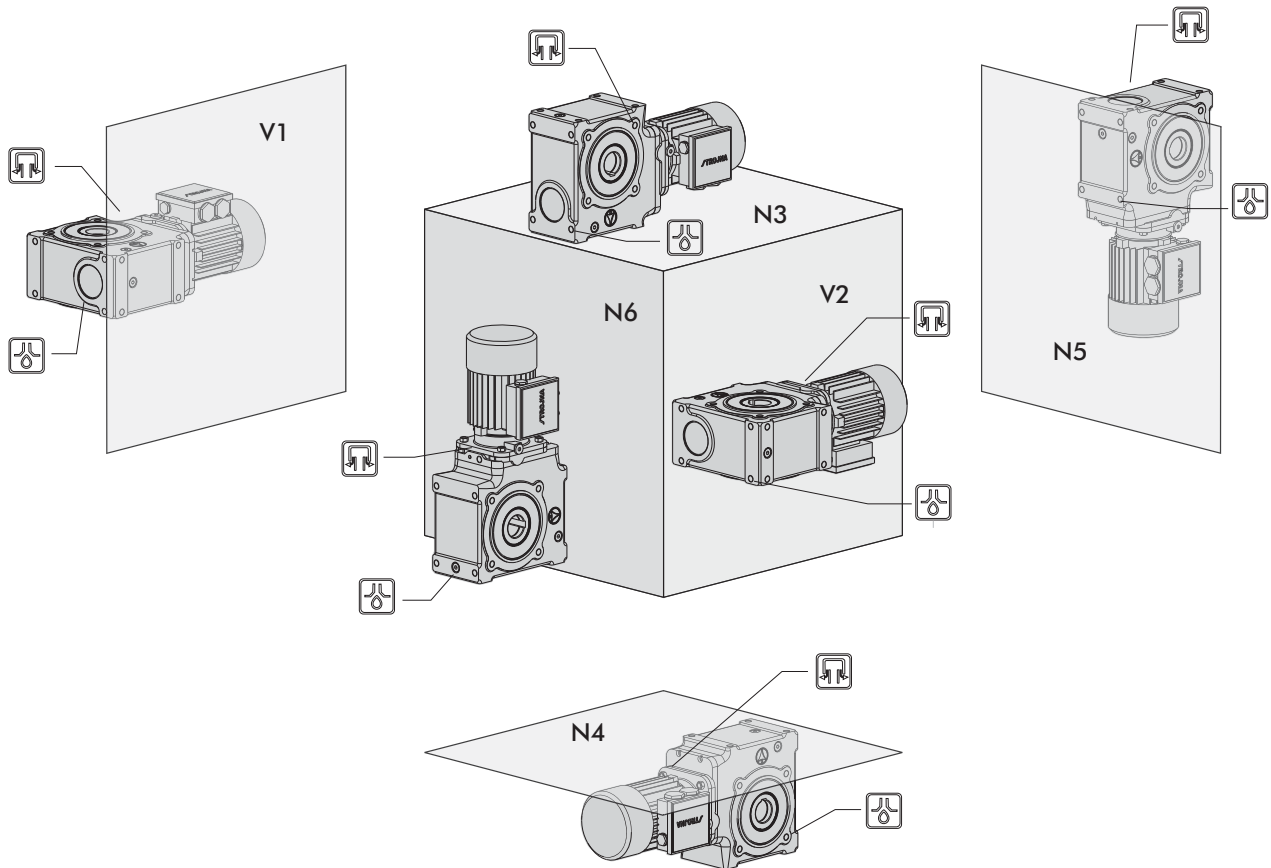

\*Check for availability

**Gear unit design**

**SG...SMB/SMR**

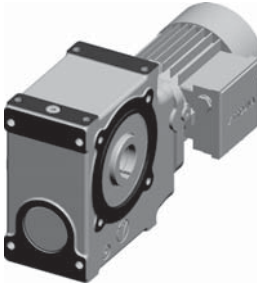

**SG...P...**

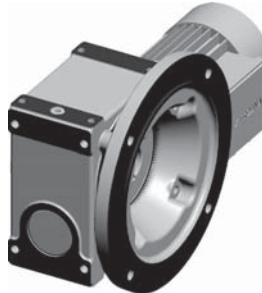

**SG...D...**

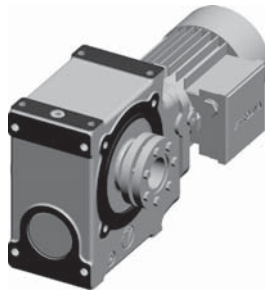

**SG...PD...**

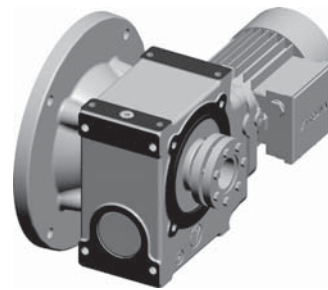

**SG...V...**

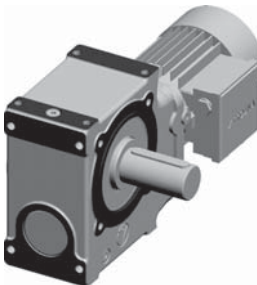

**SG...PV...**

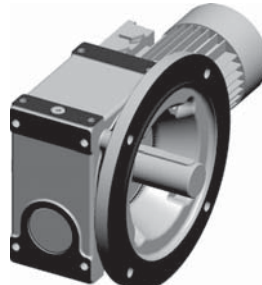

**SG...Z...**

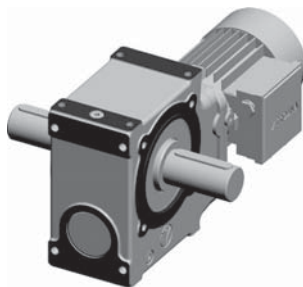

**SG...PZ...**



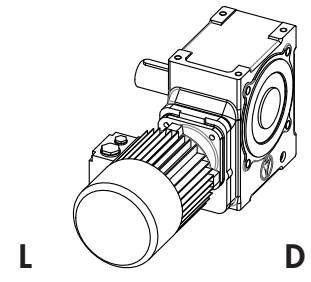
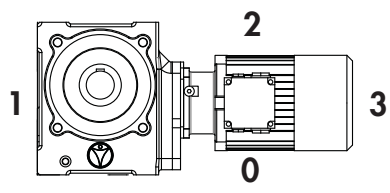
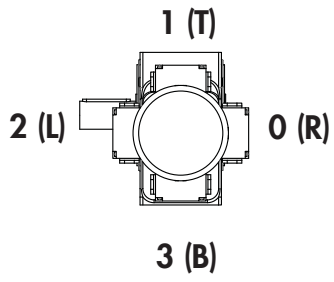

-  Vent plug
-  Drain plug

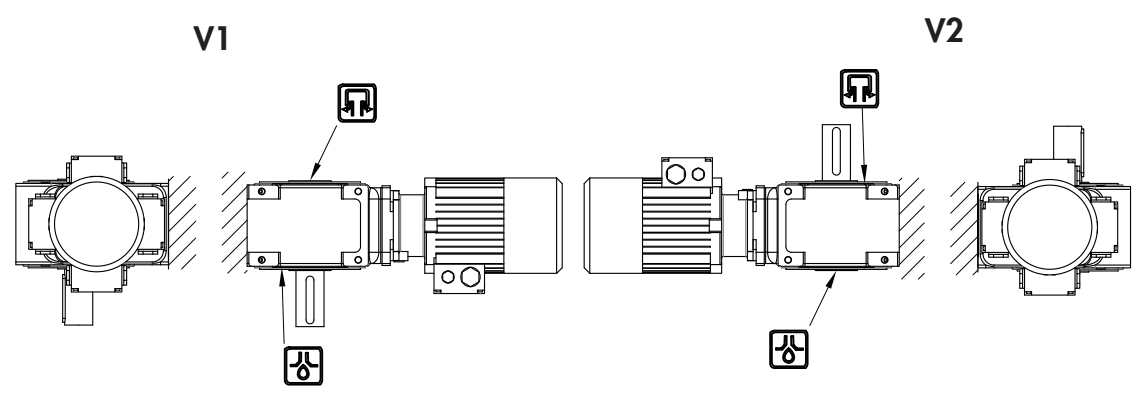
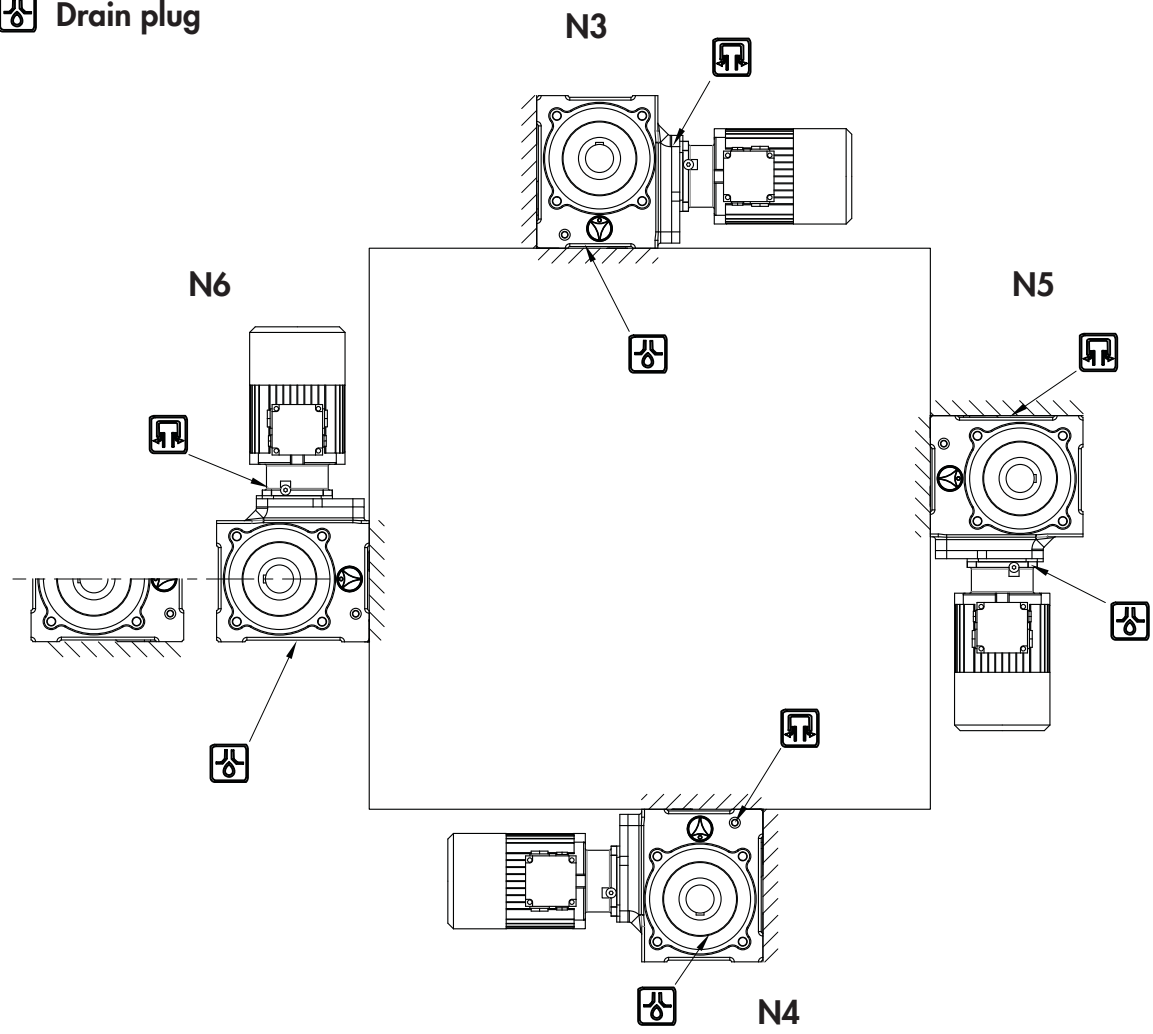

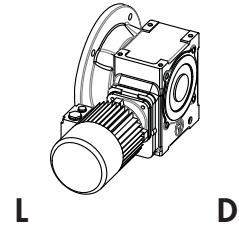
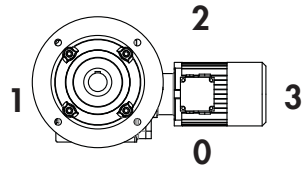
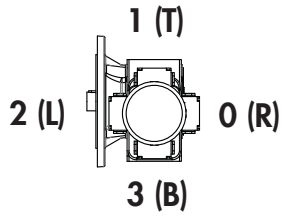

-  Vent plug
-  Drain plug

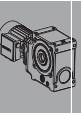
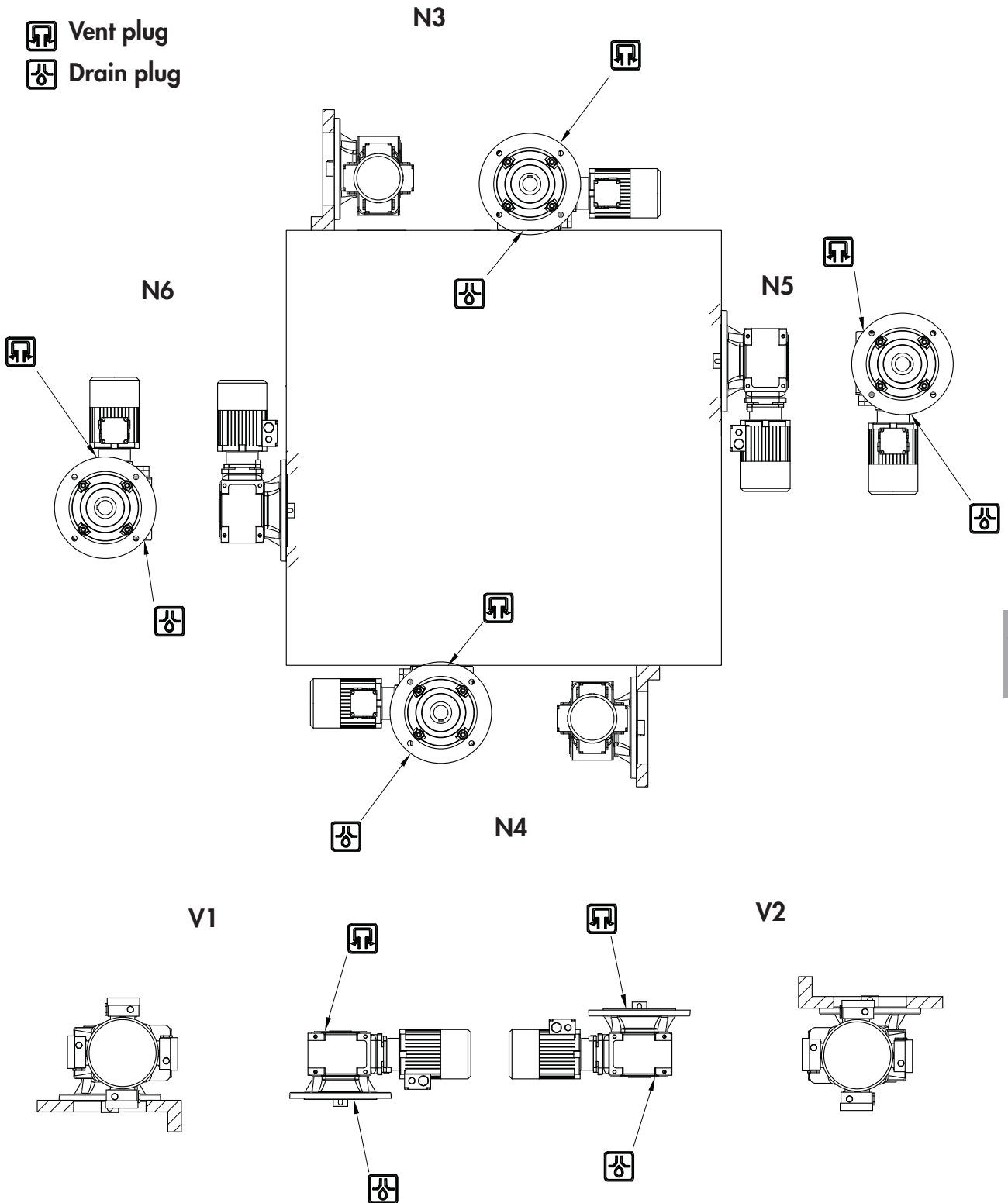

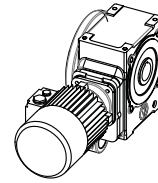
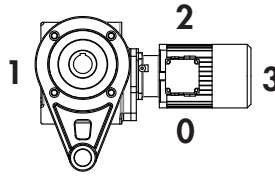
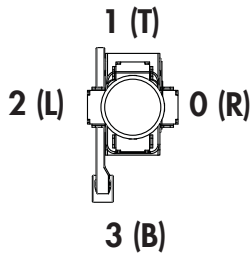

L D

-  Vent plug
-  Drain plug

